

## Detalhamento Vigas e Pilares Sem escala

VIGA BALDRAME

VB01

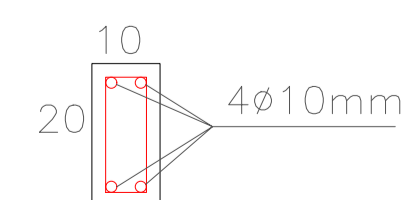

ESTRIBO

7



DETALHE PILAR

P01

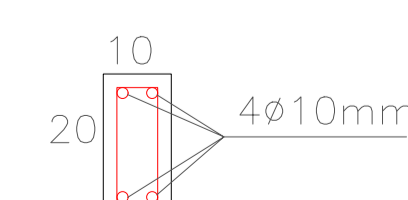

ESTRIBO

7

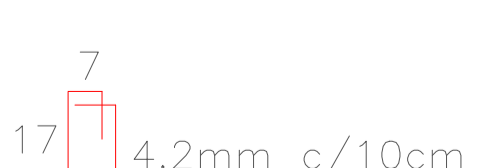

DETALHES DAS VIGAS DE RESPALDO

VR01

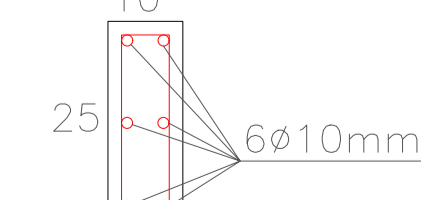

ESTRIBO

7

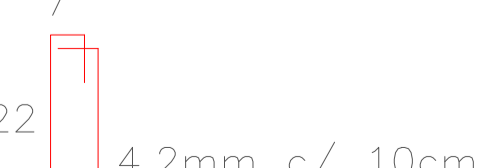

SAPATA(60x60)

S1

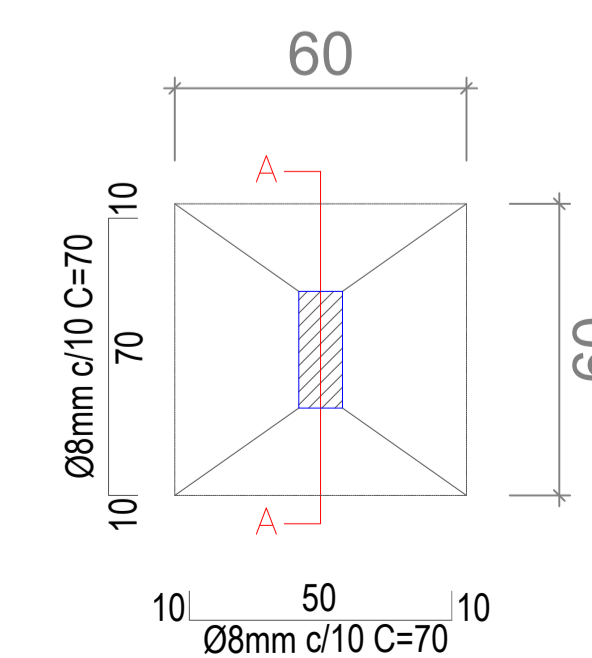
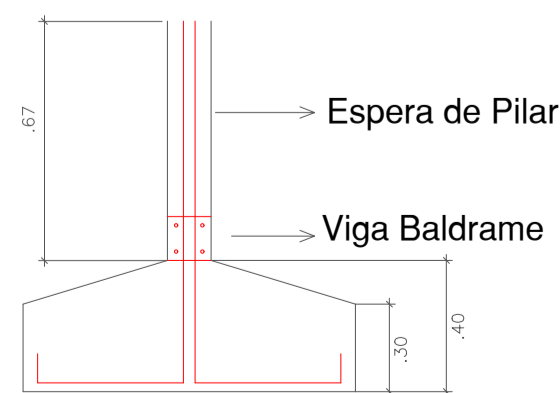

|  |  |  |              |
|--|--|--|--------------|
| <b>PROJETO ARQUITETÔNICO</b>                     |  | Nº Folhas: 01  | Folha Nº: 01 |
| Assunto:<br>Abrigo de Inversores                 |  |  |              |
| Proprietário:<br>MUNICÍPIO DE CLÁUDIA            |  | Data:<br>Novembro/2022   |              |
| Quadro de Áreas:<br>ÁREA A CONSTRUIR.....4,36 m² |  | Responsável Técnico:<br>ANDERSSON WARPECHOWSKI GRZECZINSKI<br>Engenheiro Civil CREA 49464-MT |              |
| Aprovação:                                       |  |  |              |